



ST 010 101 6705



- avec structure WAVES
- saillie 160 mm
- bec déverseur fixe
- forme de jet rectangulaire avec 40 jets individuels
- hauteur de robinetterie 108 mm
- hauteur jusqu'au mousseur 94 mm
- diamètre de percement des robinets latéraux 32 mm
- diamètre de percement du bec 35 mm
- rosace 60 x 47 mm
- 2x flexible de pression M 10 x 1 vissé, étanchéité contrôlée
- débit maxi. 4 l/min
- sans plomb
- Ce produit contribue au respect des exigences des systèmes d'évaluation des bâtiments écologiques, par exemple LEED®, BREEAM®, DGNB

	Chrome	ST 010 101 6705-00
	Platine brossé	ST 010 101 6705-06
	Dark Platinum brossé	ST 010 101 6705-99

Composants individuels de ce set







Ce set requiert les composants suivants

	1x	13 714 705-00		1x	20 005 705-00
	1x	20 005 706-00			

ST 010 101 6705



- saillie 160 mm
- bec déverseur fixe
- forme de jet rectangulaire avec 40 jets individuels
- hauteur de robinetterie 108 mm
- hauteur jusqu'au mousseur 94 mm
- diamètre de percement 35 mm
- 2x flexible de pression M 10 x 1 vissé, étanchéité contrôlée
- raccord 1/2"
- débit maxi. 4 l/min
- sans plomb
- Ce produit contribue au respect des exigences des systèmes d'évaluation des bâtiments écologiques, par exemple LEED®, BREEAM®, DGNB

	Chrome	13 714 705-00
	Platine brossé	13 714 705-06
	Dark Chrome	13 714 705-19
	Champagne brossé (Or 22cts)	13 714 705-46
	Champagne (Or 22cts)	13 714 705-47
	Dark Platinum brossé	13 714 705-99

ST 010 101 6705

mm [inches]



Diagramme de débit



Certificats

GDV_0400279. LGA_28686. IAPMO_N-4976. IAPMO_8834 (1). IAPMO_4976 (6).

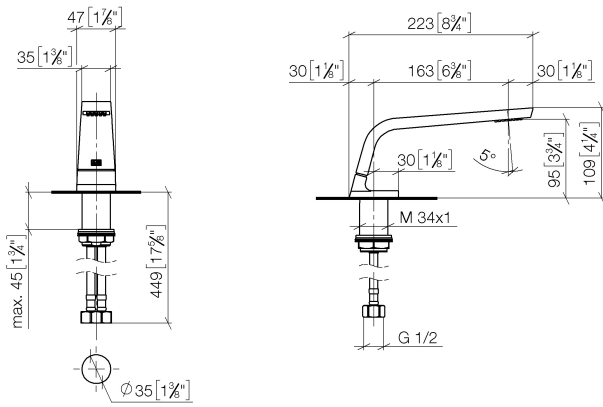
WRAS_1512011. IAPMO_6397.

ST 010 101 6705

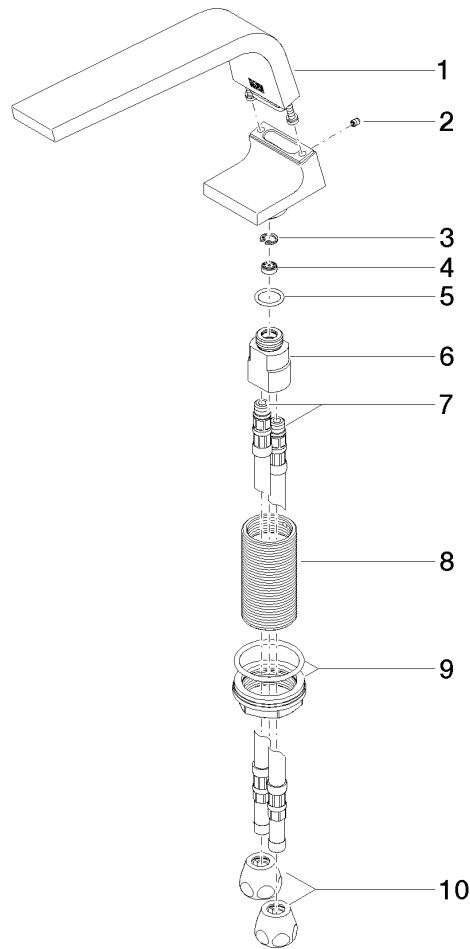







Liste des pièces de rechange

N°	Article Numéro	Désignation	Fréquence de montage	Délai de livraison
1	90 11 70 002 00-00	bec déverseur	1	10
2	09 31 11 044 90	tige	1	2
3	09 16 01 016 90	anneau	1	2
4	09 23 01 034 90	limiteur de débit	1	2
5	09 14 10 130 90	joint	1	2
6	09 11 10 055 10 90	raccord	1	2
7	04 30 04 016 00 90	flexible	2	60
8	09 30 01 208 90	raccord	1	2
9	04 23 10 044 06 90	set de fixation	1	2
10	90 23 30 040 00-00	joint américain	2	10

ST 010 101 6705



- avec structure WAVES
- diamètre de percement 32 mm
- rosace 60 x 47 mm
- avec marquage froid

	Chrome	20 005 705-00
	Platine brossé	20 005 705-06
	Dark Chrome	20 005 705-19
	Champagne brossé (Or 22cts)	20 005 705-46
	Champagne (Or 22cts)	20 005 705-47
	Dark Platinum brossé	20 005 705-99

ST 010 101 6705

mm [inches]



Diagramme de débit



Certificats

WRAS_1804020. IAPMO_4976 (5). IAPMO_N-4976. LGA_28687. IAPMO_6397.

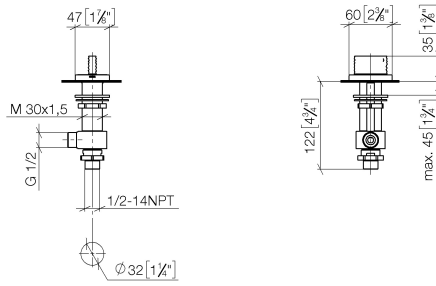
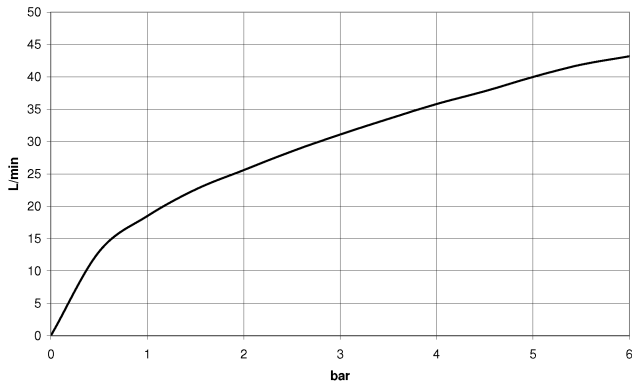
WRAS_240202020.

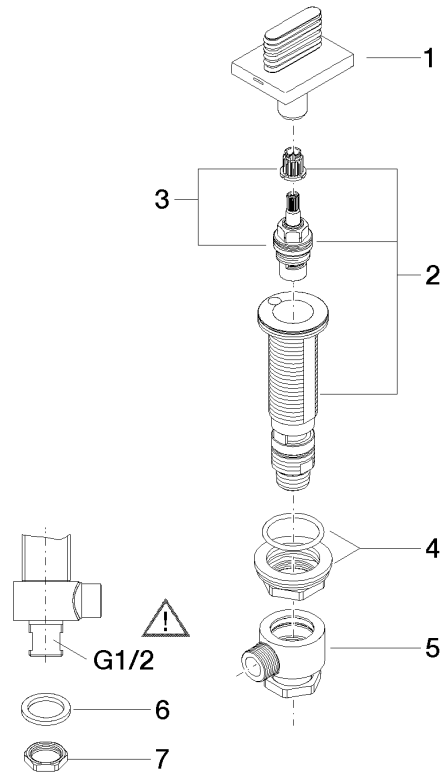







Liste des pièces de rechange

N°	Article Numéro	Désignation	Fréquence de montage	Délai de livraison
1	90 20 70 055 06-00	poignée (cold)	1	10
2	04 17 11 058 53 90	partie latérale	1	2
3	90 90 03 153 00 90	tête céramique	1	2
4	04 23 10 032 78 90	set de fixation	1	2
5	04 17 11 023 10 90	raccord multiple	1	2
6	90 23 30 040 00-00	joint américain	1	10
7	09 30 11 059 90	rondelle	1	2
8	09 23 10 012 90	écrou	1	2

ST 010 101 6705



- avec structure WAVES
- diamètre de perçement 32 mm
- rosace 60 x 47 mm
- avec marquage chaud

	Chrome	20 005 706-00
	Platine brossé	20 005 706-06
	Dark Chrome	20 005 706-19
	Champagne brossé (Or 22cts)	20 005 706-46
	Champagne (Or 22cts)	20 005 706-47
	Dark Platinum brossé	20 005 706-99

ST 010 101 6705

mm [inches]



Diagramme de débit



Certificats

WRAS_1804020. IAPMO_4976 (5). IAPMO_N-4976. LGA_28687. IAPMO_6397.

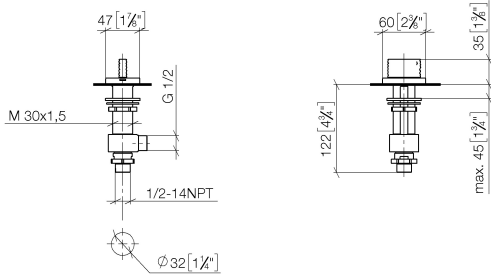
WRAS_240202020.

ST 010 101 6705

Les pièces pour les autres finitions peuvent être trouvées ici : Platine brossé

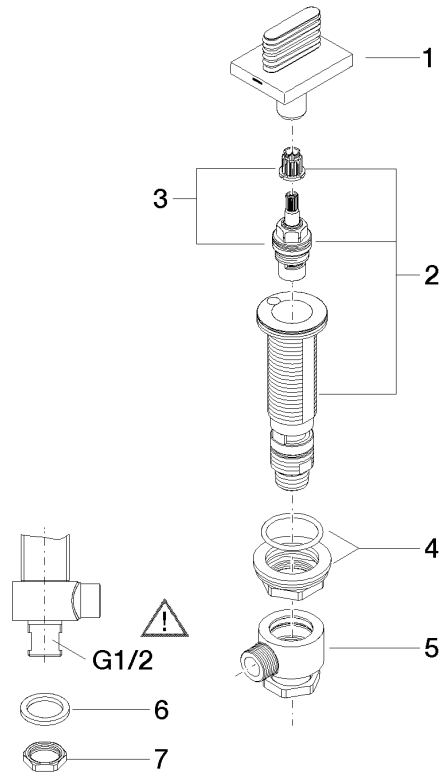

Liste des pièces de rechange

N°	Article Numéro	Désignation	Fréquence de montage	Délai de livraison
1	90 20 70 055 07-00	poignée (hot)	1	10
2	04 17 11 058 52 90	partie latérale	1	2
3	90 90 03 152 00 90	tête céramique	1	2
4	04 23 10 032 78 90	set de fixation	1	2
5	04 17 11 023 10 90	raccord multiple	1	2
6	90 23 30 040 00-00	joint américain	1	10
7	09 30 11 059 90	rondelle	1	2
8	09 23 10 012 90	écrou	1	2